

PRODUCT CATALOG 2019

KEOFITT CLASSIC M4



KEOFITT®
WORLD LEADERS IN STERILE SAMPLING™

DISTRIBUTED BY

HARCO

ENTERPRISES LTD.

1-800-361-5361

HOW IT WORKS

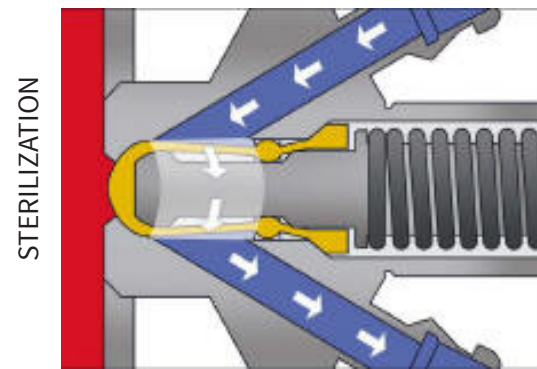
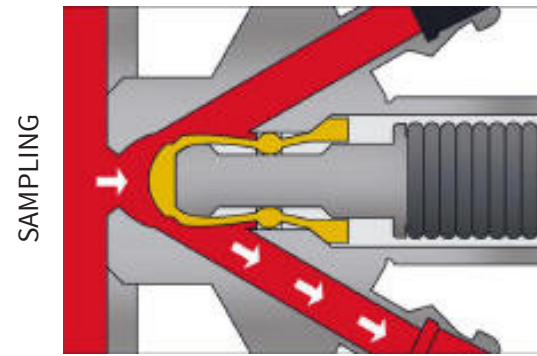

DISTRIBUTED BY
HARCO
ENTERPRISES LTD.
1-800-361-5361

KEOFITT CLASSIC M4 SAMPLING VALVE

The KEOFITT CLASSIC M4 Sampling Valve is the smallest KEOFITT valve available. It is designed for the sampling of low viscosity products in the range of 0-100 cP with particles less than 1.5 mm in diameter. Sampling of more viscous liquids is possible, only will it take longer (depending on process pressure).

This valve is used in a range of industries such as brewery, dairy, pharmaceutical and bio-tech for products such as:





- Water
- Milk
- Medical solutions
- Filtered Beer
- Perfume
- Olive Oil

Besides the selection of the Valve Body and the Valve Head there are three different membrane materials to choose from: Silicone, EPDM and PTFE.





Accessories include quick couplings for the connection of tubing, piping and more.



KEOFITT CLASSIC M4 SAMPLING VALVE - BODIES

HOSE PIECE	WELDING BODIES				
	TANK WELDING Ø28	PIPE WELDING 1"	PIPE WELDING NW25	IN-LINE VERTICAL	IN-LINE HORIZONTAL
	 400001	 400011	 400014	 400027*	 400028*

* ON REQUEST ONLY!

CONNECTION BODIES				
VARIVENT Ø50	VARIVENT Ø68	MINI CLAMP	CLAMP 1" & 1½"	THREAD M28X1,5
 400010	 400009	 400021	 400022	 400031





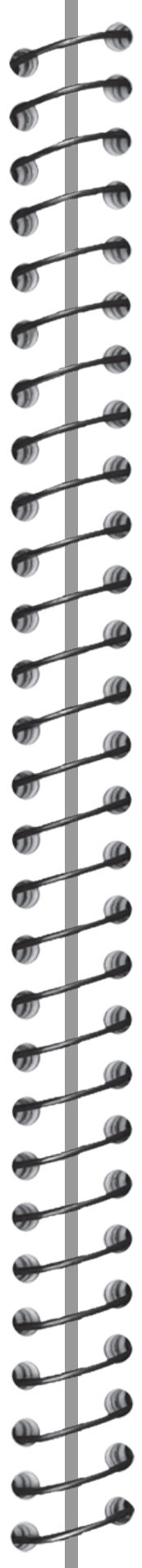













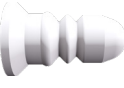







KEOFITT CLASSIC M4 SAMPLING VALVE - HEADS

















		<p>TYPE H TURN KNOB 0-10 BAR (G)</p>  <p>400041</p>	<p>TYPE K KEY RING 0-10 BAR (G)</p>  <p>400042</p>	<p>TYPE Q LEVER HANDLE 0-10 BAR (G)</p>  <p>400043</p>
M4 HEADS	SILICONE			
	EPDM	<p>400041E</p> 	<p>400042E</p> 	<p>400043E</p> 
	PTFE	<p>405541</p> 	<p>405542</p> 	<p>405543</p> 

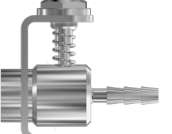

<p>TYPE N PNEUMATIC 0-10 BAR (G)</p>  <p>400044</p>	<p>TYPE N PNEUMATIC, ADJUSTABLE 0-10 BAR (G)</p>  <p>400045</p>	<p>TYPE B NO SPRING 0-12 BAR (G)</p>  <p>400047</p>
<p>400044E</p> 	<p>400045E</p> 	<p>400047E</p> 
<p>405544</p> 	<p>405545</p> 	<p>405547</p> 

KEOFITT CLASSIC M4 - PARTS & ACCESSORIES

M4™ PARTS & ACCESSORIES	O-RING	 400208 EPDM 60X3	 400308 EPDM 42X3	 400830 SILICONE 5.3X2.4	 400830E EPDM 5.3X2.4	 550184 FESTO	 600825 SILICONE 7.1X1.6	
	MEMBRANE	 400051 SILICONE	 400052 EPDM	 400055 PTFE				
	FOR HOSE PIECE	 400013 QC SPIKE	 400058 COIL	 400061 QC PLUG	 400062 RUBBER CAP	 400070 QC PIPE	 400091 QC PTFE	
	FOR VALVE HEADS	 400076 KEY RING	 400149 BUSHING	 400166 PROXIMITY SENSOR	 400167 PROXIMITY MOUNTING KIT	 400255 TOOL PTFE	 600170 LEVER HANDLE Q/N	
MISC.	 400064 DOUBLE ST. ST. CHAIN	 400067 HOSE PIECE 10/8	 900008 SOCKET ALU-TANKS	 900075 CLAMP RING 1/2"	 900086 CLAMP RING 1"	 550002.2 PTFE QC/TC 0.5M		

 800859 SILICONE 7.5X2.5	 900820 SILICONE 5.1X1.6	 900829 EPDM 21X4				
 400083 QC MINI TC	 400084 QC FOR ID 4MM	 400085 QC FOR ID 5MM	 400086 QC M4 WITH W9 HP	 550002 PTFE QC 0.5M	 550003 PTFE QC 1.0M	 550057 KÄRCHER ADAPTOR
 600370 LEVER HANDLE SELF-CLOSING	 900018 TOMMY BAR					 400082 QC M4 F/HOSE ID3.1MM
 550003.2 PTFE QC/TC 1M	 900074 GASKET EPDM 3/4"	 900087 GASKET 1/2"	 900091 GASKET EPDM 1"			

DISTRIBUTED BY
HARCO
ENTERPRISES LTD.
 1-800-361-5361