



DISTRIBUTED BY



ENTERPRISES LTD.

1-800-361-5361

Alfa Laval LKB UltraPure

Butterfly valves

Introduction

The Alfa Laval LKB UltraPure Butterfly Valve is a hygienic in-line valve for routing low and medium-viscosity liquids in stainless steel pipe systems. The LKB UltraPure is available with a standard handle with spring-locking action for straightforward manual operation or with a pneumatic actuator for pneumatic operation.

Application

This in-line butterfly valve is designed for on-off duties in high-purity applications across the personal care, biotechnology and pharmaceutical industries.

Benefits

- Versatile, highly modular design
- Competitively priced alternative to diaphragm valves in certain applications
- Full transparency and traceability of the entire supply chain due to the Alfa Laval Q-doc documentation package
- Easy to configure in either a manual version or a pneumatic version

Standard design

The LKB UltraPure Butterfly Valve consists of two valve body halves, valve disc, and bushings for the disc stem and seal ring, assembled by means of screws and nuts. The valve can also be fitted with the Alfa Laval ThinkTop® V50 and V70 for sensing and control of the valve.

Working principle

The Alfa Laval LKB UltraPure Butterfly Valve is either controlled remotely by means of a pneumatic actuator or manually by means of a handle.

For pneumatic operation, an actuator converts axial piston motion into a 90° rotation of the shaft. The actuator torque increases as the valve disc comes into contact with the seal ring of the butterfly valve to secure proper closing of the valve seat. The actuator comes in three standard versions: normally closed (NC); normally open (NO); and, air/air activated (A/A). Two actuator sizes, ø85 mm and ø133 mm, cover all valve sizes and are available in two versions, LKLA and LKLA-T (T for mounting of indication or control unit on the actuator).

For manual operation, the handle mechanically locks the valve in open or closed position. Handles are available in two positions, four positions, regulating 90° position, and multi-



position. The valve can be supplied either with welding connections or clamp connections and can be mounted with indication units for feedback on the valve position (open or closed).

TECHNICAL DATA

Valve

Max. product pressure:	1000 kPa (10 bar)
Min. product pressure:	Full vacuum
Temperature range:	-10°C to + 140°C (EPDM) However max. 95°C when operating the valve (All seals)

Actuator

Max. air pressure:	600 kPa (6 bar)
Min. air pressure, NC and NO:	400 kPa (4 bar)
Temperature range:	-25°C to +90°C
Air consumption (litres free air):	
- ø85 mm:	0.24 x p (bar)
- ø133 mm:	0.95 x p (bar)
Weight:	
- ø85 mm:	3 kg
- ø133 mm:	12 kg

ATEX

Classification:	II 2 G D ¹
-----------------	-----------------------

¹ This equipment is outside the scope of the directive 2014/34/EU and must not carry a separate CE marking according to the directive as the equipment has no own ignition source



PHYSICAL DATA

Materials

Product wetted steel part:	1.4404 (316L) acc. to EN 10088
Other steel parts:	1.4301 (304) acc. to EN 10088
Bushings for valve disc:	PVDF

Elastomers

Product wetted seals:	EPDM acc. to FDA and USP Class VI
-----------------------	-----------------------------------

Connections

Weld ends: ¹	Matching tubes and fittings: ISO 2037 / DIN / ASME BPE Acc. to ISO, DIN or ASME BPE
Clamp ends:	Matching tubes and fittings: ISO 2037 / DIN / ASME BPE Acc. to ISO, DIN or ASME BPE

¹ Weld ends on ASME BPE valves are according to ASME BPE 2009 316L Table DT-3 with low sulfur and suitable for orbital welding

Actuator

Actuator body:	1.4307 (304L)
Piston:	Light alloy Air/air version (for ø85 mm: Bronze)
Seals:	NBR
Housing for switches:	PPO

Surface specification (Product wetted steel parts)

ISO 2037 / DIN:

Internal:	0.5 µm
ASME BPE designation:	SF1
External:	Semi-bright

ASME BPE:¹

Internal:	0.5 µm
ASME BPE designation:	SF1
External:	Semi-bright

ASME BPE:¹

Internal:	0.4 µm electro polish
ASME BPE designation:	SF4
External:	Semi-bright

¹ According to ASME BPE 2009 table SF-3

Options

- Product wetted seals: FPM (acc. to FDA and USP Class VI), Q and PFA
- ThinkTop® for control and indication.¹
- Indication unit with micro switches.¹

- Indication unit with inductive proximity switches.¹
- Indication unit with Hall proximity switches.¹
- Explosion proof indication unit with inductive proximity switches.¹
- Bracket for actuator.
- Handle with two or four positions.
- Handle for electrical position indication.
- Handle with infinite intermediate positions.
- Multipositioning handle.²
- Lockable Multiposition Handle. Padlock can be mounted as shown in fig. 3. **Note!** Padlock is not delivered.
- Special cap for 90° turned handle position.
- Service tool for actuator.
- Service tool for fitting 25-38 mm (DN25 - DN40) valve discs.

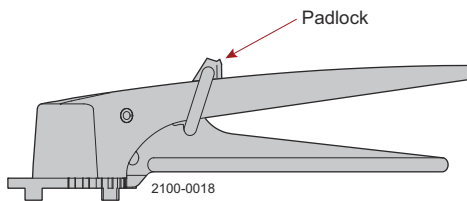

Figure 1. Lockable Multiposition Handle with padlock

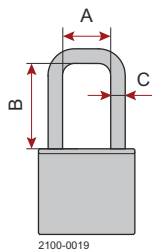

Figure 2. Dimensions - padlock

- A. Min. 20 mm
- B. Min. 35 mm
- C. ø6 mm

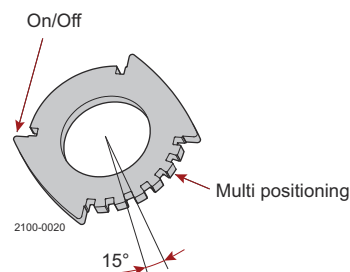

Figure 3. Positioning cap



Note! For Ultra Pure ASME BPE clamp valve (size 1" - 2½")

Installation and removal of some clamp rings is easiest by removal of the lockable multi position handle first.

Documentation

All valves are delivered with Alfa Laval Q-doc.



Note! For further details, see also ESE01699.

¹ For further information see Product Catalogue chapter "Control & Indication".

² **Note!** A padlock can be mounted on the Lockable Multiposition. Handle as shown in the opposite figure. Padlock is not delivered.

Capacity/Pressure drop diagrams

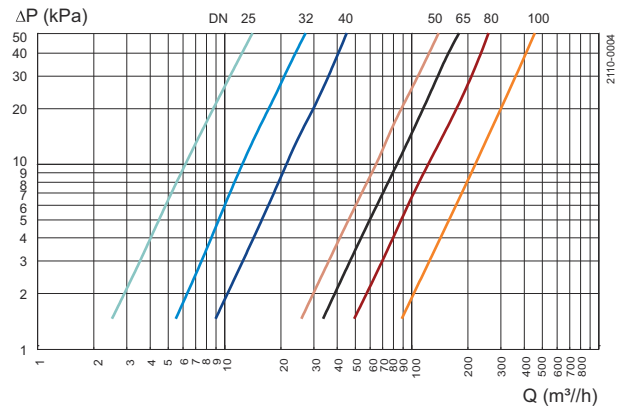
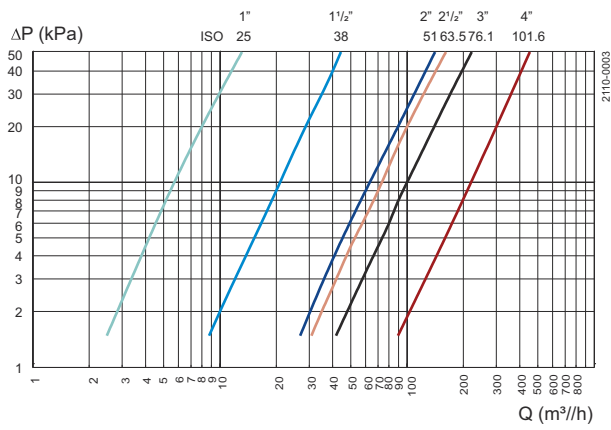

Note! For the diagrams the following applies:
 Medium: Water (20°C).
 Measurement: In accordance with VDI 2173.

Torque diagrams - Actuator

LKLA $\varnothing 85$ mm:

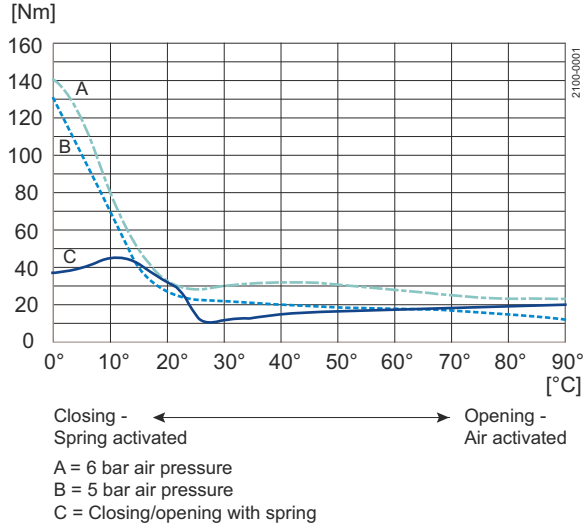

Figure 4. NC

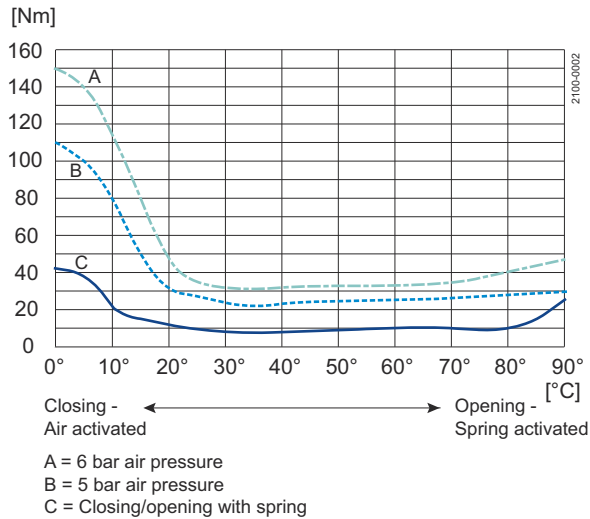

Figure 6. NO

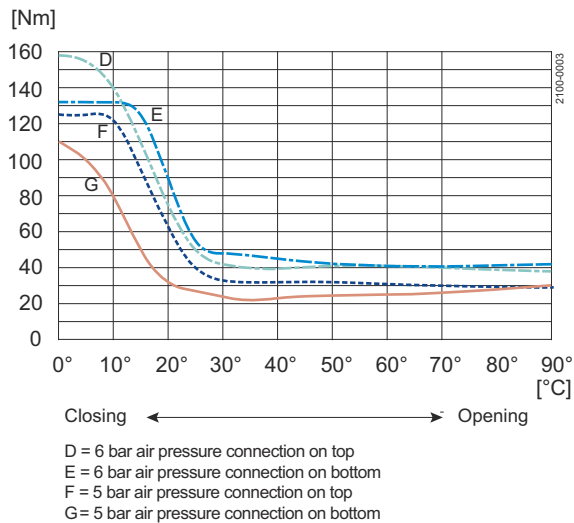

Figure 8. A/A

LKLA $\varnothing 133$ mm:

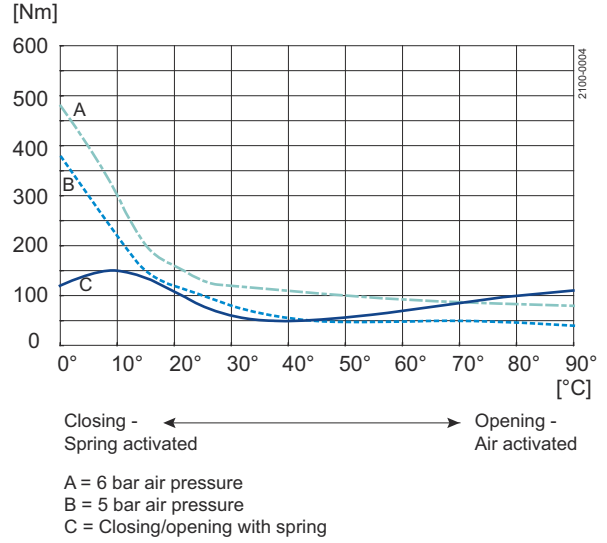

Figure 5. NC

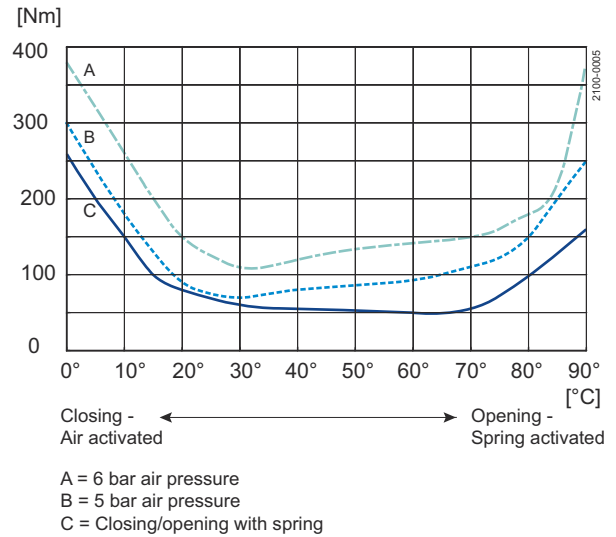

Figure 7. NO

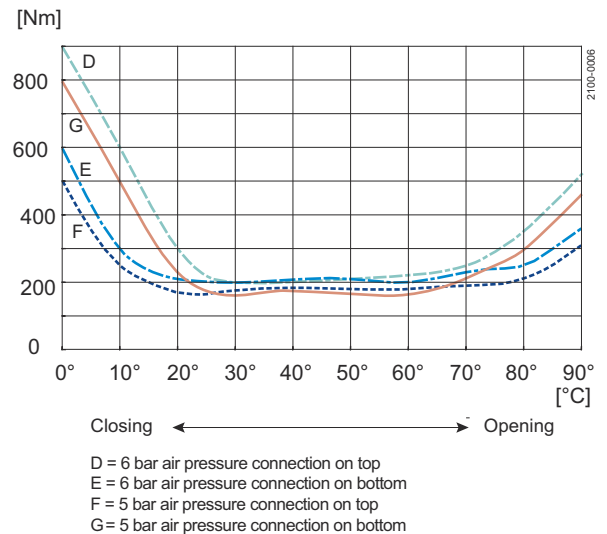

Figure 9. A/A

Torque values (for rotating the valve disc in a dry seal ring)

Size		Max. Nm
25 mm	DN25	15
	DN32	15
38 mm	DN40	15
51 mm	DN50	20
63.5 mm	DN65	25
76 mm	DN80	30
101.6 mm	DN100	35

Dimensions (mm)

Dimensions - valve

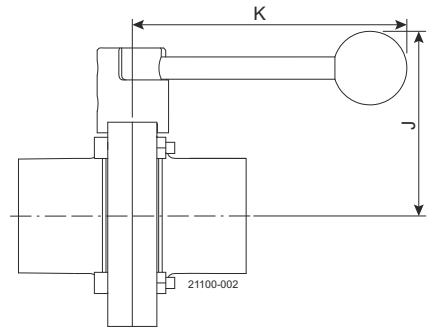
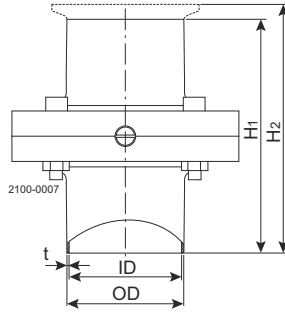
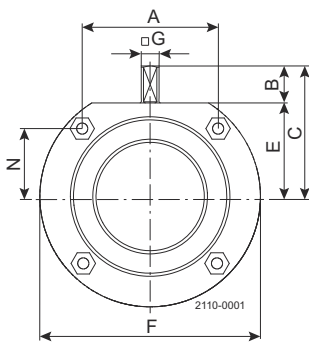

Dimensions - actuator

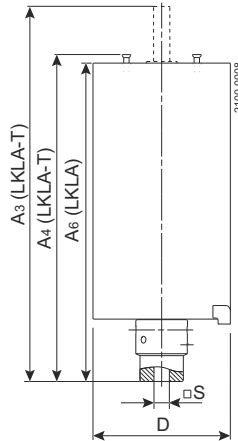
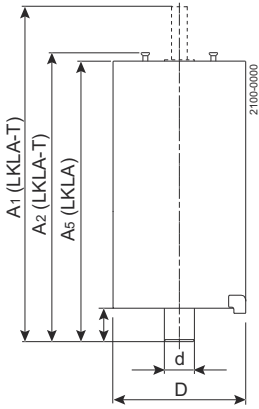

Figure 10. a. Without coupling.

Figure 11. b. With coupling.

Dimensions (mm)

LKB UltraPure

Size	ISO 2037						DIN						
	25	38	51	63.5	76.1	101.6	DN	DN	DN	DN	DN	DN	DN
	mm	mm	mm	mm	mm	mm	25	32	40	50	65	80	100
A	42.00	42.00	61.00	61.00	79.50	106.00	42.00	42.00	42.00	61.00	61.00	79.00	106.00
B	15.50	16.70	16.60	17.50	16.60	16.00	14.70	15.90	16.70	16.60	17.50	16.00	160.00
C	49.00	49.00	58.50	69.50	73.50	93.00	48.00	49.00	54.00	63.00	75.00	79.00	93.00
OD	25.00	38.00	51.00	63.50	76.10	101.60	29.00	35.00	41.00	53.00	70.00	85.00	104.00
ID	22.60	35.60	48.60	60.30	72.90	97.60	26.00	32.00	38.00	50.00	66.00	81.00	100.00
t	1.20	1.20	1.20	1.60	1.60	2.00	1.50	1.50	1.50	1.50	2.00	2.00	2.00
E	32.50	32.50	42.00	52.00	57.00	77.00	33.30	33.30	37.70	46.60	57.30	63.00	77.00
F	78.00	78.00	99.00	117.00	132.00	169.00	79.00	79.00	86.50	105.70	125.00	143.00	169.00
□S	8	8	8	8	10	12	8	8	8	8	10	10	12
H1	127.00	127.00	132.00	134.00	162.00	180.00	127.00	127.00	127.00	132.00	142.00	164.00	180.00
H2	104.20	104.20	109.20	111.20	176.40	194.40	90.00	90.00	90.00	95.00	118.00	120.00	136.00
J	82.00	82.00	92.00	102.00	107.00	127.00	74.00	74.00	78.00	88.00	98.00	104.00	118.00
K	120.00	120.00	120.00	120.00	162.00	162.00	120.00	120.00	120.00	120.00	162.00	162.00	162.00
N	26.50	26.50	30.50	40.50	43.50	53.00	27.30	27.30	31.70	35.10	45.80	49.50	53.00
Weight (kg)	1.2	1.0	1.5	2.1	3.0	4.7	1.2	1.1	1.3	1.8	3.1	3.5	5.1

ASME						
Size	mm	mm	mm	mm	mm	mm
A	42.00	42.00	61.00	61.0	79.50	105.90
B	15.50	16.70	16.60	17.50	16.61	16.00
C	49.00	49.00	58.50	69.50	73.66	93.00
OD	25.40	38.10	50.80	63.50	76.2	101.60
ID	22.10	34.80	47.50	60.20	72.90	97.00
t	1.65	1.65	1.65	1.65	1.65	2.10
E	32.50	32.50	42.00	52.00	56.99	77.00
F	78.00	78.00	98.80	117.00	132.00	169.00
□ S	8.00	8.00	8.00	8.00	10.00	12.00
H ₁	127.00	127.00	132.00	134.00	162.00	180.00
H ₂	72.40	72.40	77.40	79.40	87.37	111.80
J	82.00	82.00	92.00	102.00	107.01	127
K	120.00	120.00	120.00	120.00	162.00	162.00
N	26.50	26.50	30.50	10.50	43.50	53.00
Weight (kg)	1.20	1.00	1.50	2.10	3.00	4.70



Note! Weights are for valves with welding ends and handles.

Dimensions (mm) - Actuator

LKLA and LKLA-T:

Valve size	25-63.5 mm DN25-50	76.1 mm DN65-80	101.6 mm DN100	101.6 mm DN100
A ₁	244	242	242	363
A ₂	193	191	191	316
A ₃	244	244	244	337
A ₄	173	173	173	290
A ₅	185	183	183	308
A ₆	165	165	165	282
D	85	85	85	133
d	17	17	17	30
l	16.5	16.5	16.5	34
□ s	8	10	12	12
Function	NC, NO, A/A	NC, NO, A/A	NC, NO, A/A	NC, NO, A/A

Connections

Compressed air

R¹/₈" (BSP), internal thread.

DISTRIBUTED BY

ENTERPRISES LTD.
 1-800-361-5361

This document and its contents are subject to copyrights and other intellectual property rights owned by Alfa Laval Corporate AB. No part of this document may be copied, re-produced or transmitted in any form or by any means, or for any purpose, without Alfa Laval Corporate AB's prior express written permission. Information and services provided in this document are made as a benefit and service to the user, and no representations or warranties are made about the accuracy or suitability of this information and these services for any purpose. All rights are reserved.

How to contact Alfa Laval

Up-to-date Alfa Laval contact details for all countries are always available on our website at www.alfalaval.com