



DISTRIBUTED BY



ENTERPRISES LTD.

1-800-361-5361

Alfa Laval Unique SSV Y-body

Single seat valves

Introduction

The Alfa Laval Unique SSV Y-body is a versatile, reliable pneumatic single seat valve with a single contact surface between the plug and the seat to minimize the risk of contamination. Its compact, modular and hygienic design meets the highest process demands in terms of hygiene and safety.

Built on the well-proven Alfa Laval Unique SSV platform, the Unique SSV Y-body provides uninterrupted flow and gentle handling of products that are highly viscous or contain large particles and require gentle product treatment.

Few moving parts ensure easy dismantling, high reliability and low maintenance costs. A wide range of optional features enables customization to specific process requirements.

Application

This robust single seat valve is designed for uninterrupted flow and gentle handling of products that are highly viscous or contain large particles in hygienic applications across the dairy, food, beverage, brewery and many other industries.

Benefits

- Exceptional valve hygiene and durability
- Extended seal life due to the defined seal compression
- Enhanced product safety due to the static seal leak detection
- Protection against full vacuum due to the double lip seal
- Gentle product handling

Standard design

The Unique SSV Y-body is available in a one-body configuration, with easy-to-configure valve bodies, plugs, actuator and clamp ring.

The valve seals are optimized for durability and long service life through a defined compression design. The actuator is connected to the valve body using a yoke and all components are assembled with a clamp ring.

The valve can also be fitted with the Alfa Laval ThinkTop V50 and V70 for sensing and control of the valve.



Using the Alfa Laval Anytime configurator, it is easy to customize to meet virtually any process requirement.

Working principle

The Alfa Laval Unique SSV Y-body is operated by means of compressed air from a remote location. The valve can be controlled using an Alfa Laval ThinkTop®.

TECHNICAL DATA

Temperature

Temperature range: 14 °F to +284 °F (EPDM)

Pressure

Max. product pressure (depending on valve specifications): 145 PSI (10 bar)

Min. product pressure: Full vacuum

Air pressure: 72.5 to 101.5 PSI (5 - 7 bar)

Actuator function

- Pneumatic downward movement, spring return
- Pneumatic upward movement, spring return
- Pneumatic upward and downward movement (A/A)

PHYSICAL DATA

Materials

Product wetted steel parts: AISI 316L (internal Ra < 32 µ inch)

Other steel parts: AISI 304

Product wetted seals: EPDM

Other seals: NBR

Plug seal: PTFE (TR2)

Options

- Control and Indication: IndiTop, ThinkTop or ThinkTop Basic
- Product wetted seals in HNBR/NBR or FPM



Note!

For further details, see instruction ESE00583.

Other valves in the same basic design

- Single seat valve
- Reverse acting valve
- Long stroke valve
- Manually operated valve
- Aseptic valve

Semi-Maintainable actuator comes with 5 year warranty.

Dimensions (inch)

	Nominal Size			
	2"	2.5"	3"	4"
A	17.32	17.95	22.05	24.41
C	7.88	9.25	10.38	12.63
ID	1.86	2.36	2.86	3.81
F ₁	1.97	1.97	2.64	2.64
H	4.53	4.53	6.14	6.14
Weight (lb)	18.9	24.5	41.1	59.7

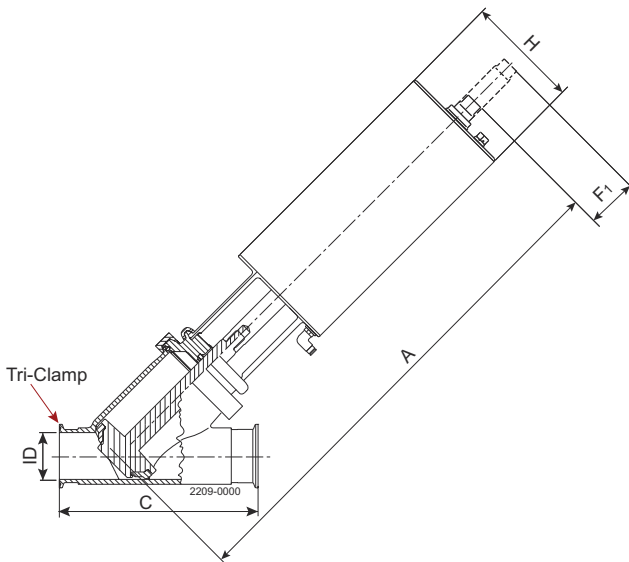

Figure 1. Y-body valve

Caution, opening/closing time:

Opening/closing time will be effected by the following:

- The air supply (air pressure)
- The length and dimensions of the air hoses
- Number of valves connected to the same air hose
- Use of single solenoid valve for serial connected air actuator functions
- Product pressure

Air Connections Compressed air:

R 1/8" (BSP), internal thread.

Air Consumption (In³ free air) for one stroke

Size	2" - 2½"	3" - 4"
NO and NC	3.39 x air pressure [PSI]	8.52 x air pressure [PSI]
A/A	5.79 x air pressure [PSI]	16.2 x air pressure [PSI]

Pressure drop/capacity diagrams

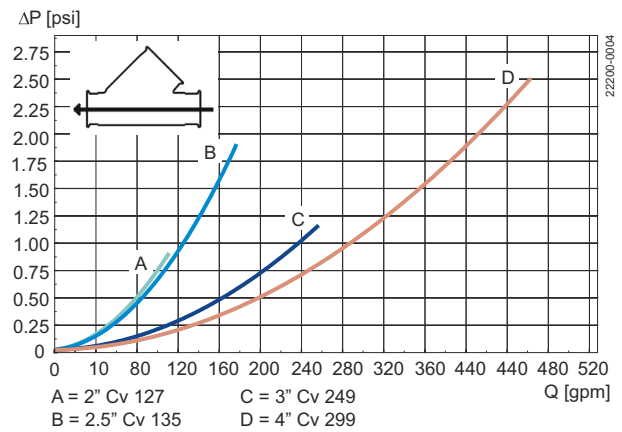
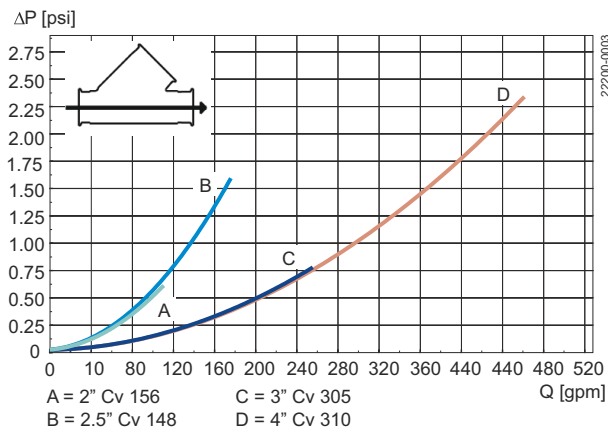

Note!

For the diagrams the following applies:

Medium: Water (68° F/20° C)

Measurement: In accordance with VDI2173

Pressure drop can also be calculated in Anytime configurator.

Pressure drop can also be calculated with the following formula:

$$Q = K_v \times \sqrt{\Delta p}$$

Where

Q = Flow (gallon/minute).

Cv = gallon/minute at a pressure drop of 1 psi (see table above).

Δp = Pressure drop in psi over the valve.

Where

Q = Flow (gallon/minute).

Cv = gallon/minute at a pressure drop of 1 psi (see table above).

Δp = Pressure drop in psi over the valve.

2.5" shut-off valve, where Cv = 128 (See table above).

$$Q = K_v \times \sqrt{\Delta p}$$

$$160 = 128 \times \sqrt{\Delta p}$$

$$\Delta p = \left(\frac{160}{128}\right)^2 = 1,6 \text{ psi}$$

(This is approx. the same pressure drop by reading the y-axis above)

Pressure data for Unique Single Seat Valve Y-body

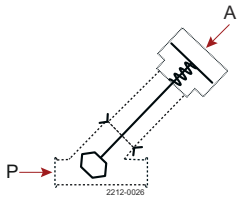

Figure 2. 1

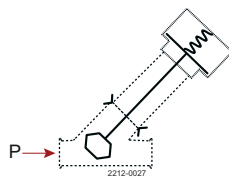

Figure 3. 2

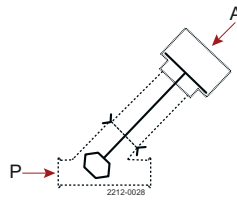

Figure 4. 3

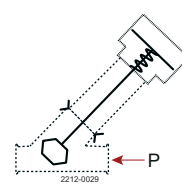

Figure 5. 4

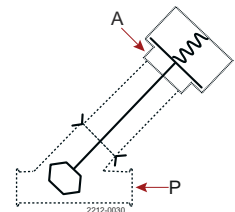

Figure 6. 5

A = Air

P= Product pressure

Actuator / Valve body combination and direction of pressure	Air pressure (PSI)	Plug position	Max. pressure in psi without leakage at the valve seat			
			Valve size			
			2"	2½"	3"	4"
Figure 2. 1	87	NO	71	40	55	31
Figure 3. 2		NC	64	35	55	31
Figure 4. 3	87	A/A	145	103	137	78

Actuator / Valve body combination and direction of pressure	Air pressure (PSI)	Plug position	Max. pressure in psi without leakage at the valve seat			
			Valve size			
			2"	2½"	3"	4"
Figure 5. 4		NO	133	74	94	54
Figure 6. 5	87	NC	142	79	95	54

This document and its contents are subject to copyrights and other intellectual property rights owned by Alfa Laval Corporate AB. No part of this document may be copied, re-produced or transmitted in any form or by any means, or for any purpose, without Alfa Laval Corporate AB's prior express written permission. Information and services provided in this document are made as a benefit and service to the user, and no representations or warranties are made about the accuracy or suitability of this information and these services for any purpose. All rights are reserved.

200004012-2-EN-US

© Alfa Laval Corporate AB

How to contact Alfa Laval

Up-to-date Alfa Laval contact details for all countries are always available on our website at www.alfalaval.com

DISTRIBUTED BY
HARCO
ENTERPRISES LTD.
1-800-361-5361

