



Since 1964

SANITARY DIGITAL THERMOMETERS CATALOG





Supply House to the Processing Industries Since 1964

Trusted supply house of sanitary processing equipment, parts and supplies for the dairy and food, brewery, beverage and pharmaceutical industries.

Harco Enterprises offers a diverse line of sanitary and hygienic processing equipment, parts and supplies including pumps, sanitary valves, separators, homogenizers, gaskets and fittings, sanitary hoses, and instrumentation as well as a variety of other products from world leading manufacturers such as Alfa Laval, Ampco, Tetra Pak, Burkert, Tri-Clover, Remco, Vikan, Carlisle, Haynes, Strahman, and more.

These products are distributed to dairy, food, beverage processing facilities as well as the pharmaceutical, brewing, and fisheries industries throughout North America.

Many of our products are customized in design due to strict sanitary and hygienic standards, and all are built to stand up to the demands of high production environments. Resourcefulness and quick delivery are important to you, and Harco always provides both.

Check out our large collection of equipment, parts and supplies, including our line of color-coded products available.

Visit our website today at www.harcosupply.com

Sanitary Digital Thermometers

SANI-FLOW

FEATURES

The Sani-Flow Sanitary Digital Thermometer is built to withstand the harshest environment and function for many years with little or no maintenance. Our dedication to quality is not only evident in our products, but also in our customer service. We offer immediate availability on all products and respond quickly with quality service at reasonable prices. We feel so strongly about the quality of our products and service that we guarantee complete satisfaction.

Accuracy: $\pm 0.5^\circ$ across the full scale with large, high contrast LCD display so there is no guessing, squinting or misreading the temperature. No problem reading several thermometers at one time from a distance.

Durability: Constructed with 316L stainless steel wetted surfaces to assure maximum corrosion resistance. A clean waterproof design allows the thermometer to be hosed down or submersed for cleaning. The Lexan® lens is virtually impervious to cracks and breakage.

Dependability: Powered by two field replaceable standard AAA battery with a life of up to 3 years - no expensive battery pack. Totally electronic which means no hassles with mercury or a separated column. The RTD does not wander or drift like other RTD type thermometers which means fewer recalibrations will be necessary.

Versatility: One thermometer covers a range from -58° to 302° . There is no need to have different thermometers for different applications.

Field Recalibratable: Simply turn a screw on the electronics to adjust calibration. No special tools or charts needed. Check and adjust quickly and easily during routine maintenance or battery replacement.

Special Probe Lengths available in a matter of days not weeks.

A Unique Modular Design means any thermometer can be customized for tough, abusive or special applications.

Repairable: The modular design also allows for cost effective and timely repairs.

Service: Thermometers are available from stock ready to ship. No hassle return policy. No restocking charge on standard thermometers.

SPECIFICATIONS

TOLERANCES

Compliance	3-A, NEMA 4X, IP67
Accuracy	$\pm 0.5^\circ\text{F}$ ($\pm 0.3^\circ\text{C}$)
Units	$^\circ\text{F}$ or $^\circ\text{C}$ - Field Selectable
LCD Display Size	1" (2.54 cm)
Refresh Rate	Once per Second
Process Temperature Range	More Info - Process
Temperature Range	-58° to 302°F (-50° to 150°C)
Ambient Operating Limits	-40° to 176°F (-40° to 80°C)
Ambient Storage Limits	-40° to 185°F (-40° to 85°C)

CONSTRUCTION

Product Contact Material	316L Stainless Steel
Product Contact Finish	$R_a \text{ max} = 8 \mu\text{in}$ (0.20 μm)
Case & Lens Ring Material	304L Stainless Steel
Lens Material	$\frac{1}{4}$ " Polycarbonate
Power	Standard AAA Batteries
Battery Life Expectancy	1 to 3 Years
Approx. Shipping Weight	2 Pounds (0.9 Kg)

Tri-Clamp® is a registered trademark of Tri-Clover, Inc.

FITTINGS

STYLE	SIZE	PROBE LENGTH	CODE
Tri-Clamp®	$\frac{1}{2}$ "	2 $\frac{1}{4}$ "	1/2U
	$\frac{3}{4}$ "	2 $\frac{3}{8}$ "	3/4U
	1"	2 $\frac{5}{8}$ "	1U
	1 $\frac{1}{2}$ "	2 $\frac{3}{4}$ "	1$\frac{1}{2}$U
	2"	3 $\frac{1}{2}$ " or 5 $\frac{1}{2}$ "	2U
	2 $\frac{1}{2}$ "	3 $\frac{1}{2}$ "	2$\frac{1}{2}$U
	3"	3 $\frac{3}{4}$ "	3U
	4"	4 $\frac{1}{2}$ "	4U
	Projectile Well	-	3 $\frac{3}{4}$ "
-		9 $\frac{1}{8}$ "	9PW
-		10 $\frac{1}{2}$ "	10PW
-		12 $\frac{1}{8}$ "	12PW
NPT 1/4" - 3/4"	-	9"	NPT
Split Ferrule	-	5 $\frac{3}{4}$ "	5SP
Air Space	-	3 $\frac{3}{4}$ "	3A
	-	5"	5A
	-	7 $\frac{1}{4}$ "	7A
#13H Captive Nut & #14 Bevel Seat	1"	1 $\frac{3}{4}$ "	1T
	1 $\frac{1}{2}$ "	2 $\frac{1}{4}$ "	15T
	2"	2 $\frac{5}{8}$ "	2T

STYLE	SIZE	PROBE LENGTH	CODE
Cherry-Burrell	1"	1 $\frac{5}{8}$ "	1I
	1 $\frac{1}{2}$ "	2 $\frac{3}{16}$ "	1$\frac{1}{2}$I
Male I-Line	2"	2 $\frac{1}{2}$ "	2I
	2 $\frac{1}{2}$ "	2 $\frac{7}{8}$ "	2$\frac{1}{2}$I
	3"	3 $\frac{3}{16}$ "	3I



Sanitary Digital Thermometers

Typical Fittings

LEFT SIDE MOUNT

(shown with 1 1/2" Tri-Clamp®)



RIGHT SIDE MOUNT

(shown with 1 1/2" Tri-Clamp®)



BACK MOUNT

(shown with 1 1/2" Tri-Clamp®)

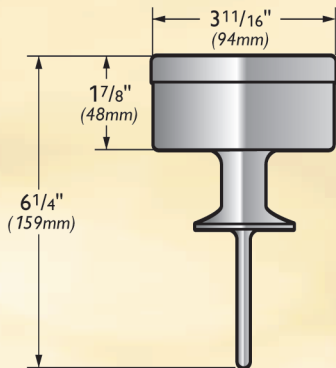

BOTTOM MOUNT

(shown with 1 1/2" Tri-Clamp®)

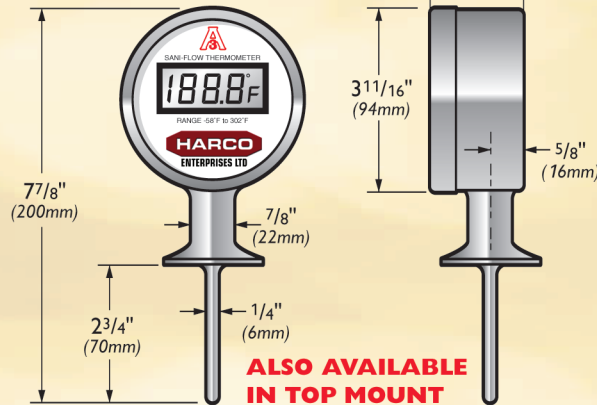

ALSO AVAILABLE
IN TOP MOUNT

AIR SPACE



PROJECTILE WELL

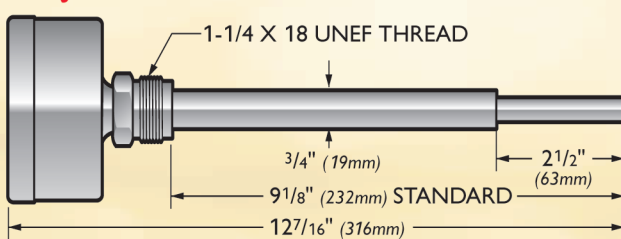

SPLIT FERRULE

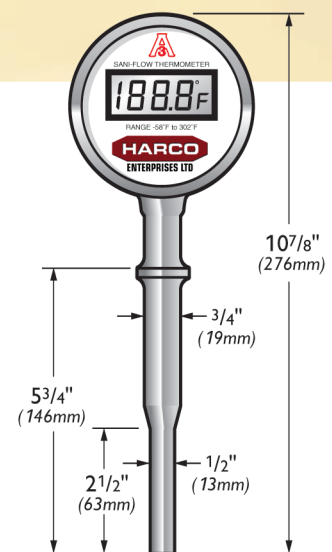

PIPE THREAD (NPT)

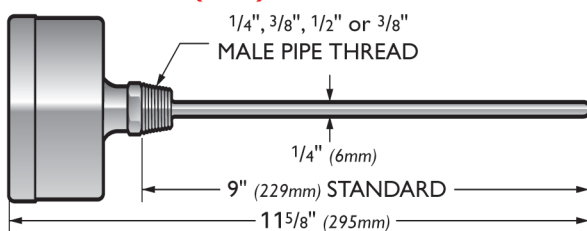

REMOTE MOUNT

(shown with 1/2" NPT)

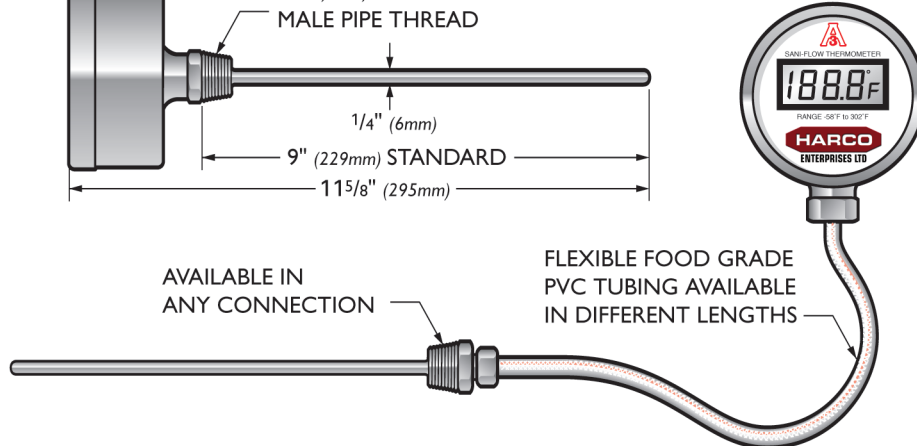

Sanitary Digital Thermometers

ORDERING INFORMATION

Below are typical examples of models with their descriptions.

EXAMPLE 1:

DT - 1½U - BT - DF

Describes a Sani-Flow Digital Thermometer with 1½" tri-clamp fitting, bottom mounted with °F display.

EXAMPLE 2:

DT - 2U - LF - DC

Describes a Sani-Flow Digital Thermometer with 2" tri-clamp fitting, left side mounted with °C display.

EXAMPLE 3:

DT - ½NPT - BK - DF

Describes a Sani-Flow Digital Thermometer with ½" pipe thread fitting, back mounted with °F display.

EXAMPLE 4:

DT - 9PW - BK - DF

Describes a Sani-Flow Digital Thermometer with 9-1/8" projectile well fitting, back mounted with °F display.

MODEL NUMBER CONSISTS OF:

SERIES	FITTING	MOUNT	DISPLAY
DT	2U	BT	DF

Please make a selection from each category below:

SERIES

DT - Sani-Flow Digital Thermometer

SANITARY FITTINGS

(Fittings available in ½", ¾", 1½", 2", 2½", 3" & 4")

- H** G&H "H" Line Male
- I** Cherry-Burrell Male I-Line
- K** APC "K" Clamp
- Q** Cherry-Burrell Q-Line
- T** #13H Captive Nut & #14 Bevel Seat
- U** Tri-Clamp®

(Specify size, then adapter type such as 1½U for 1½" Tri-Clamp adapter.)

OTHER FITTINGS

(Specify probe length)

- A** Air Space
- M** Umbrella Fitting
- NPT** ¼", 3/8", ½", 5/8" or ¾" Pipe Thread
- PW** Projectile Well with 1¼- 18 UNEF Male Thread
- SP** Split Ferrule
- VP** - VAT Well Fitting with #13H Captive Nut
- OF** - No Fitting

MOUNT

- BT** Bottom Mount
- RT** Right Side Mount
- LF** Left Side Mount
- TP** Top Mount
- BK** Back Mount
- BTR** Remote Fitting

DISPLAY

- DF** °F (Fahrenheit) - Standard
- DC** °C (Celsius)



- Plate Heat Exchangers
- Valves
- Separators
- Gaskets
- Pumps



Brushes

- Sparta Brushes **Remco**
- Stainless Steel Sponges **Vikan**
- Nylon Scouring Pads
- Squeegees **CARLISLE**
- Janitorial Supplies



FLUID CONTROL SYSTEMS

- Sanitary & Utility Valves
- The Universal Control Top For Hygienic Process Valves



Gaskets & Fittings

- Sanitary (Bevel Seat)
- Alloy Products
- Cherry Burrell
- G&H-Clamp & Flat Seat
- John R. Perry Sanitary
- Tri-Clover (Clamp)
- DeLaval
- Clamp Fittings
- Weld Fittings
- NPT Fittings
- S S Tubing





- Homogenizers & Parts
- Plate Heat Exchangers
- Separators

Hose & Tubing

- Steam Hose
- Instrumentation Tubing
- Sanitary Hose for Food & Beverage Applications
- Food Master Sanitary Hose



Lubricants

- Haynes Sprays
- Lubri-Film
- Petro Gel
- CIP Lube
- Harco HL-7
- Moovit Sprays



Blending & Mixing Systems

- Powder Mixers
- Dry & Liquid Blenders
- Shear Blenders
- Dry Hopping Units
- Twin Screw Pumps



AMPCO APPLIED PRODUCTS

Pails & Utensils

- Stainless Steel Containers
- Stainless Steel Sanitary Pails
- Scoops & Dippers
- H-Duty Sanitary Shovels
- Pitch & Cheese forks and more...



Pumps & Parts

- Alfa Laval
- Ampco
- APV *Repair Service For All Makes.*
- DeLaval
- Fristam
- G&H Centrifugal Pumps and Parts
- Jabsco
- Tetra Pak
- Tri-Clover
- Waukesha



Washdown Equipment

- Mixing Units
- Hose Stations
- Hose Assemblies
- Water Saver Nozzles
- Hose Racks
- Hose Accessories



Strakman ARCHON



Ampco Pumps

- ZP1, ZP2 & ZP3 SERIES Pumps - All Stainless Steel Gear Case!
- LC/LD/LF Series Pumps
- AC + Series Pumps
- Master Distributor for Ampco *Ampco Pump Company*



Thermometers & Gauges

- Thermometers
- Sanitary Instrumentation
- Homogenizer Gauges
- Sani-Flow Gauges
- Digital Thermometers

Tri-Clover Inc.

- Positive Rotary Pumps
- Centrifugal Pumps
- Replacement Parts
- Valves
- Fittings

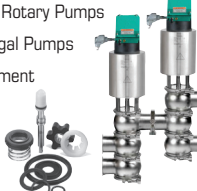

Miscellaneous

- Cleaners
- Pads & Sponges
- Kettles
- Aprons
- Disinfectant Mats
- Plastic Shovels
- Tools & Accessories
- Recorder Charts
- Pens



Spare Parts for All Makes

- Homogenizers & Parts
- Heat Exchangers
- Pumps
- Valves
- Blenders
- Tuchenhagen



Harco distributes equipment and replacement parts for the following lines:

